

# 2MP ColorHunter With Smart Dual Light Turret Analog Camera

UAC-T142-AF28(40)LM-DL



## Introduction

UAC-T142-AF28(40)LM-DL is a 2MP ColorHunter with smart dual light turret analog camera with a high-performance 1/3-inch CMOS sensor and 3D noise reduction technology. It supports TVI/AHD/CVI/CVBS, which effectively enhances product adaptability and diversity of networking solutions. With SYV-75-3 or other coaxial cable types, the camera can achieve low-cost, long-distance, and anti-interference mega-pixel HD video transmission without time delay. The camera also supports audio input and synchronous transmission of audio and video. With UNV XVR, our ColorHunter cameras equipped with Smart Dual Light can intelligently switch between IR and white light when detecting a target or not, offering flexible lighting options and enhancing security.

## Features

- High quality imaging with 2MP resolution
- TVI/AHD/CVI/CVBS
- Supports IR-cut filter with auto-switch (ICR)
- Smart Dual Light
- 3D noise reduction technology delivers clean and sharp images
- Supports 180° horizontal flip, 180° vertical flip
- OSD configuration menu, easy to operate
- IP67 waterproof and dustproof design, high reliability
- OSD configuration menu in 11 languages
- Built-in microphone for high quality audio transmission via coaxial cables

## Specifications

Model	UAC-T142-AF28LM-DL	UAC-T142-AF40LM-DL
<b>Sensor</b>		
Pixel	2MP	
Size	1/3"	
Minimum illumination	0.003 lux (F1.6, AGC ON) 0 lux (Illuminator ON)	
<b>Lens</b>		
Lens	2.8mm	4.0mm
Lens mount	M12	
Angle of view	H: 100.9° V: 56.5° D: 121.8°	H: 82.5° V: 42.1° D: 98.6°
<b>Illuminator</b>		
Illuminator	Two IR illuminators; Two white-light illuminators	
Illumination distance	IR: 40m (131.23 ft) White light: 40m (131.23ft)	
Lifetime	≥60,000 hours	
<b>Video</b>		
Resolution	1080P: 1920(H)×1080(V) 720P: 1280(H) ×720(V)	
Frame rate	TVI/AHD/CVI: 1080P@25fps (default TVI), 1080P@30fps; 720P@25fps, 720P@30fps CVBS: PAL, NTSC	
Shutter time	PAL: 1/25s-1/50000s NTSC: 1/30s-1/50000s	
<b>Image</b>		
Exposure mode	Four modes: Global (default), BLC, HLC, DWDR	
Day/Night	Three modes: Auto (default), Day, Night	
Digital noise reduction	2D/3D	
White balance	Two modes: Auto (default), Manual	
WDR	DWDR	
Light mode	Dual light (default), Infrared, White light	
Flip	Supports 180° horizontal flip, 180° vertical flip	
Defog	NA	
<b>Audio</b>		
Microphone	Built-in Mic	
Camera audio	TVI: 1080P@25fps, 1080P@30fps CVI: 1080P@25fps, 1080P@30fps	
<b>Interface</b>		
Power	5.5mm power interface	
Video output	BNC, supports TVI/AHD/CVI/CVBS	
<b>Operating environment</b>		
Temperature	-30°C to 60°C (-22°F to 140°F)	
Humidity	≤95% (RH, non-condensing)	
Surge protection	4kV	
<b>General</b>		

Power	DC 12V ( $\pm 25\%$ ), with reverse polarity protection, Max 3.6W
Mount	Surface mount (default), optional backbox, wall mount bracket
Dimensions	$\Phi 117.8\text{mm} \times 96.5\text{mm}$ (diameter*height)
Material	Metal+Plastic
Weight	238g (0.52lb)
OSD menu language	11 Languages English, German, Spanish(Latin America), French, Italian, Japanese, Korean, Polish, Portuguese(Brazil), Russian, Turkish
<b>Certification</b>	
EMC	CE-EMC (EN 55032, EN 61000-3-3, EN IEC 61000-3-2, EN 55035) FCC (FCC 47 CFR part 15 B)
Safety	CE-LVD (EN 62368-1)
Environment	CE-RoHS (2011/65/EU; (EU)2015/863); WEEE (2012/19/EU)
Protection	IP67 (IEC 60529)

## Dimensions

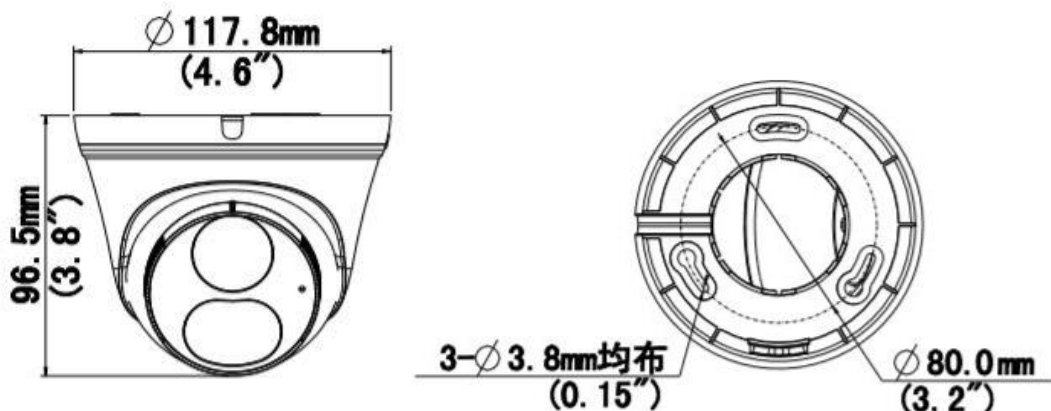

UAC-T142-AF28(40)LM-DL

## Accessories

TR-JB03-I-IN

Junction Box



TR-JB07/WM03-G-IN

Wall Mount



TR-WM03-D-IN

Wall Mount

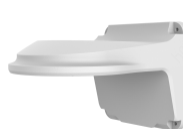

TR-WM07P-B

Wall Mount



TR-A01-IN

Waterproof Joint



TR-UP06-IN

Pole Mount



TR-UC08-C

Corner Mount

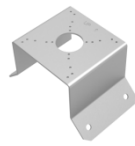

TR-SE24-A-IN

Pendant Mount



TR-CM24-IN

Pendant Mount



TR-SE24-IN

Pendant Mount



PWR-DC1201A-UK,  
PWR-DC1201B-UK

Wall Plug-in UK  
Power Adapter



PWR-DC1201A-US,  
PWR-DC1201B-US

Wall Plug-in US  
Power Adapter



PWR-DC1201A-EU,  
PWR-DC1201B-EU

Wall Plug-in EU  
Power Adapter



PWR-DC1201A-IND

Wall Plug-in IND  
Power Adapter



Mount

TR-JB07/WM03-G-IN(TR-WM03-D-IN)+TR-UP06-IN

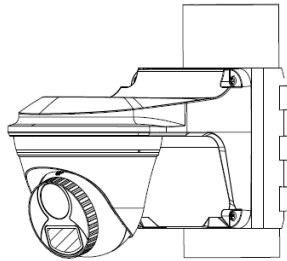

TR-JB03-I-IN

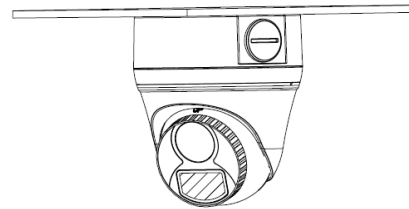

TR-JB07/WM03-G-IN(TR-WM03-D-IN)+TR-UC08-C

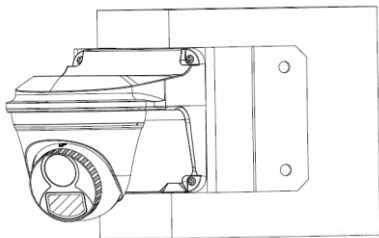

TR-CM24-IN+TR-JB03-I-IN

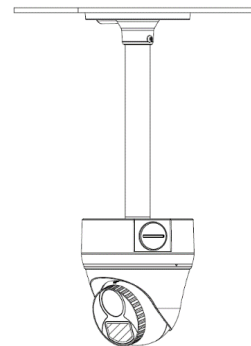

TR-WM07P-B

TR-JB07/WM03-G-IN(TR-WM03-D-IN)

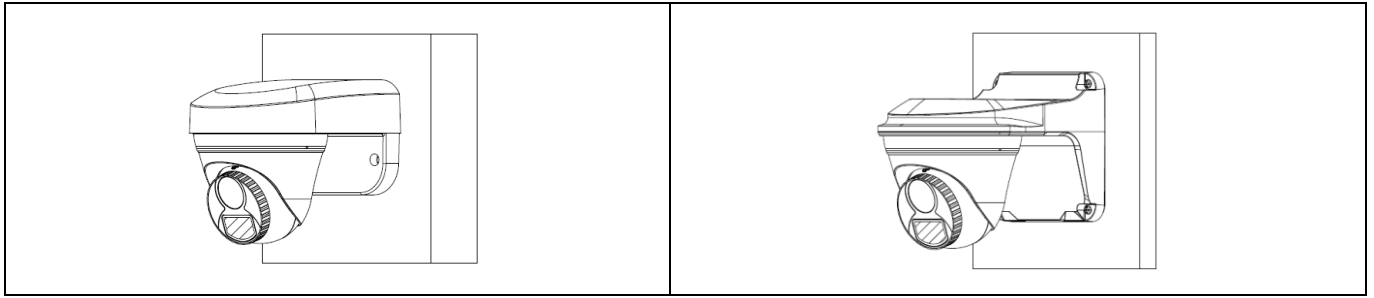

**Zhejiang Uniview Technologies Co., Ltd.**

Building No. 369, Xietong Road, Xixing Sub-district, Binjiang District, Hangzhou City, Zhejiang Province, China (310051)

Email: [overseasbusiness@uniview.com](mailto:overseasbusiness@uniview.com); [globalsupport@uniview.com](mailto:globalsupport@uniview.com)

<https://www.uniview.com>

©2023 Zhejiang Uniview Technologies Co., Ltd. All rights reserved.

\*Product specifications and availability are subject to change without notice.